

User manual of ZWK15 controller

Contents

1. Description.....	2
2. Installation of ZWK15 controller.....	3
3. Controller programming	4
3.1. Adding device to network (INCLUDE function).....	5
3.2. Associating device with a pair of buttons on the controller (ASSOCIATE function).....	6
3.3. Associating another controller with the network (LEARN MODE).....	7
3.4. Deleting device from a pair of controller buttons (DELETE function).....	8
3.5. Excluding device from the network (EXCLUDE function).....	9
3.6. Restoring default settings in the controller (DEFAULT function).....	10
3.7. Removing SECONDARY controller from the network	10
3.8. Special function ASSAIN A ROUTE.....	11
4. Technical parameters	11
5. Remote control.....	12
6. Battery replacement.....	13
7. WARRANTY.....	14

1. Description

The ZWK15 (wall keyboard) enables remote control of electronic accessories compatible with the “Z-Wave” system, e.g. ZWS12 or ZWS30 motors for operating FAKRO roof windows. The ZWK15 controller can operate up to 15 devices separately. The single button in the upper section (No. 3 – *Figures 1*) allows selecting one of the five channels (No. 2 – *Figures 1*) with which devices can be associated. The fifth channel is signalized by all 4 LEDs.

The ZWK15 controller is equipped with a two-way “Z-Wave” communication radio module. For communication, the Z-Wave module exploits radio wave frequency of 868,42 MHz. In *Figure 1*, there is presented a general view of the ZWK15 keyboard with description of available buttons and signaling.

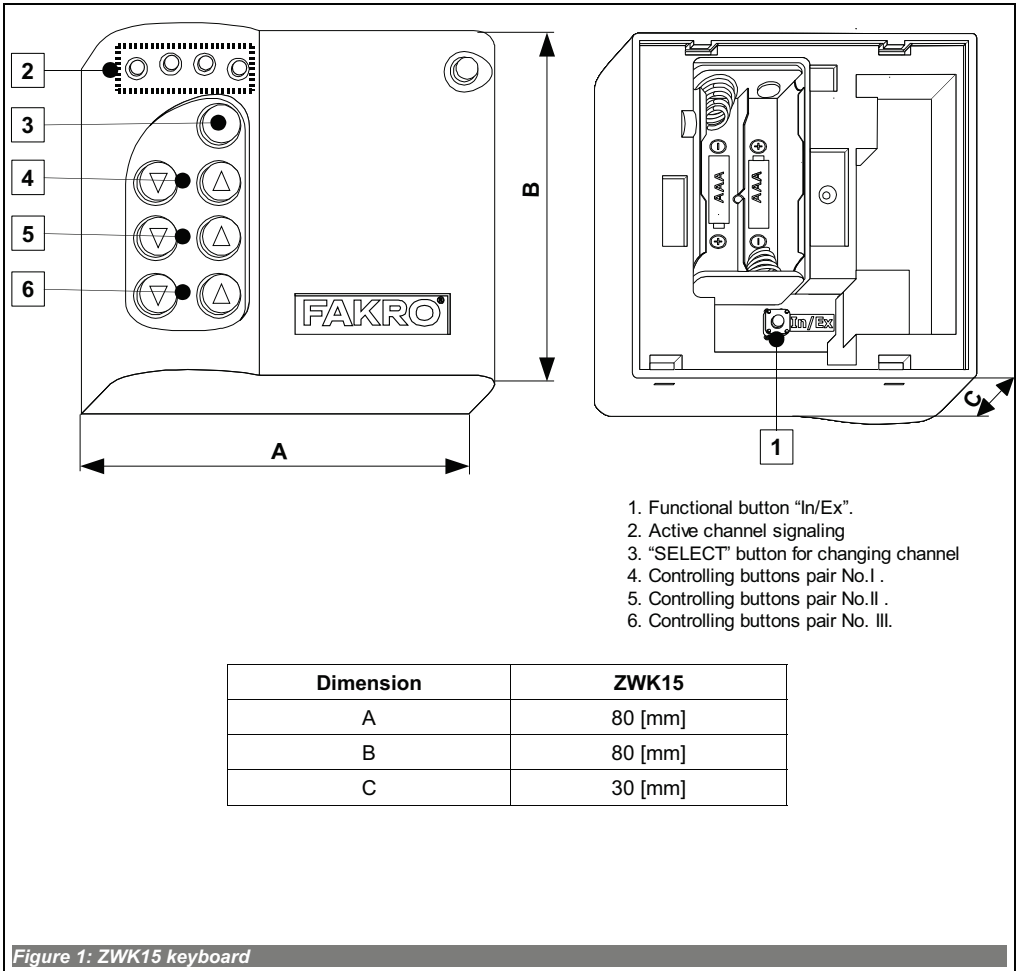

2. Installation of ZWK15 controller

The ZWK15 controller should be attached to the wall or other permanent building element by means of two screws driven into cylindrical plugs placed in the openings drilled earlier in the wall.

1. Fix the holder to the wall using included screws driven into wall plugs placed in the drilled openings.

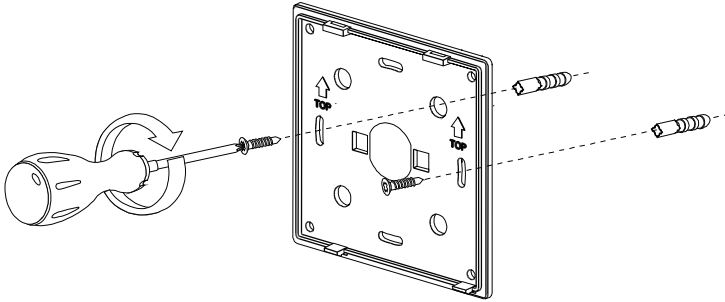

2. Place the ZWK15 controller onto the holder.

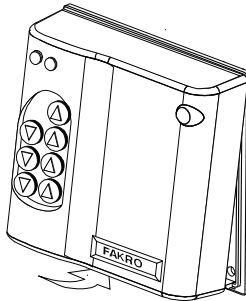

3. Controller programming

In order to operate FAKRO electronic accessories, featuring Z-Wave system, by means of the ZWK15 controller, it is necessary to:

1. Add the device to the “Z-Wave” network (INCLUDE function) – see section 3.1 and
2. Associate the device with a selected pair of buttons on the controller with which user wishes to operate the device (ASSOCIATE function) – see section 3.2.

In one “Z-Wave” network, there can be included a maximum of 232 devices, i.e. controllers, electronic accessories for FAKRO roof windows as well as other electronic devices.

Note !!! Each device physically deleted from the network (e.g. damaged) shall be deleted from the controller's memory (PRIMARY, SECONDARY), that is, first deleted from a pair of buttons (section 3.4) and then deleted from the network (3.5). Appropriate implementation of procedures aims to provide optimal communication between devices. Disconnecting the device without deleting it from the controller's memory will result in longer time of reaction of devices on commands and faster running out of batteries. In case of necessity of deleting damaged device, which deleting from the controller's memory is not possible, it is recommended to re-configure the whole network (all devices). Configuration of the new network begins with restoring the controller to factory settings (DEFAULT function), and then EXCLUDE function is used and next we go further to the section 3 „Controller programming”.

Note !!! When moving the device within the network, it is recommended to delete it from the controller's memory (first deleting from a pair of buttons, section 3.4) and then deleting it from the network (section 3.5) and re-adding after installation in new workplace.

3.1. Adding device to network (INCLUDE function)

Adding a device to the “Z-Wave” network is possible only via “PRIMARY” controller (every single brand new controller is set as primary controller by default). In each network, there is always only one primary controller and any other added to it is identified as “SECONDARY”. The procedure of device adding to the network is presented in *Figure 2*.

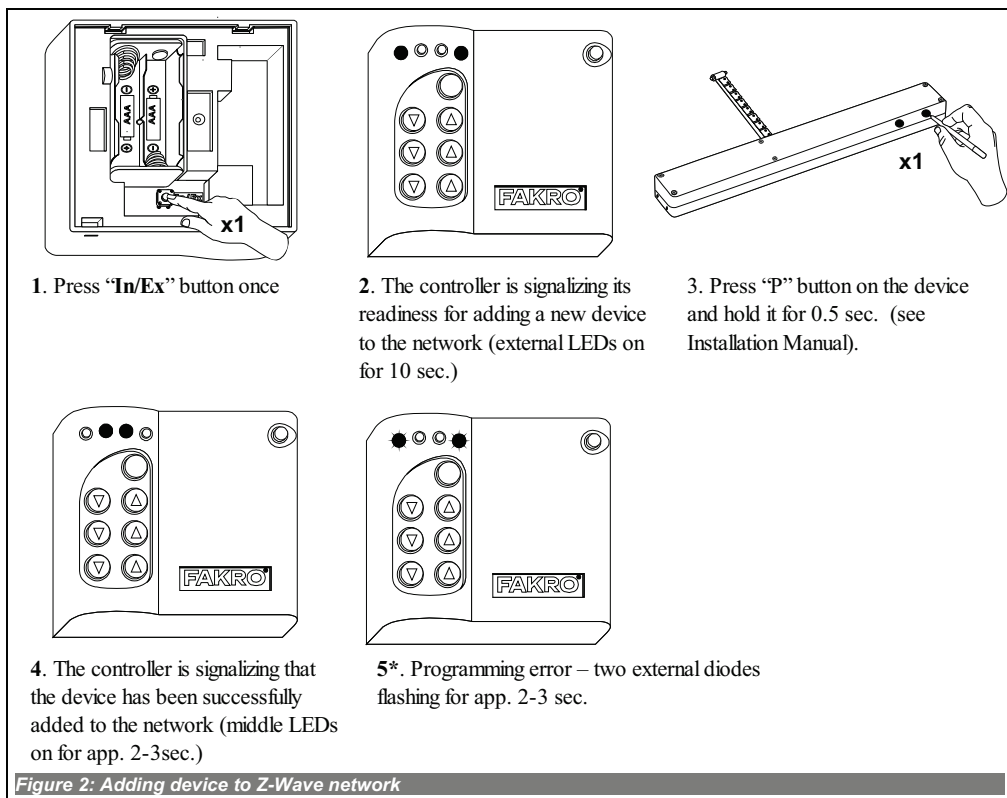

*) Programming error can be caused by:

- no button being pressed within 10 seconds from controller signaling its readiness for adding a new device to the network;
- long distance between controller and device being added;
- the device already belonging to other network. It is necessary to use EXCLUDE function and repeat the procedure of device adding to the network.

3.2. Associating device with a pair of buttons on the controller (ASSOCIATE function)

Associating the device with a pair on buttons on the controller, which has been already included in the Z-Wave network according to section 2.1, makes it possible to operate the device. This procedure can be carried out on the primary and secondary controllers. The procedure of associating the device with buttons is presented in *Figure 3*.

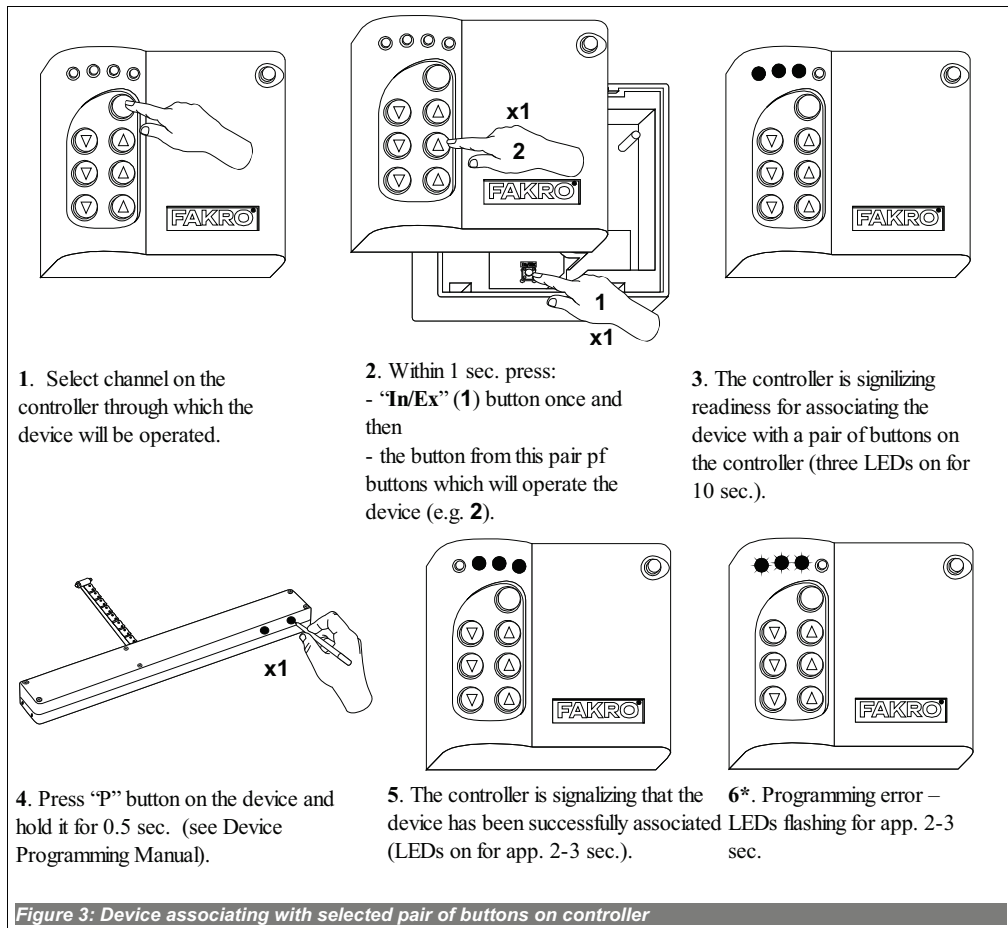

*) Programming error can be caused by:

- no button being pressed within 10 seconds from the controller signaling its readiness for associating a new device with the network;
- long distance between the controller and device being added;
- device already belongs to another network or it has not been associated with any network. It is necessary to perform EXCLUDE function on the device and repeat INCLUDE and ASSOCIATE functions.

3.3. Associating another controller with the network (LEARN MODE)

Associating further controllers with the network makes them being categorized as “SECONDARY”. Associating a controller with the Z-Wave network consists in sending data to it from the PRIMARY controller. The procedure of controller associating is presented in *Figure 4*. In order to assure the best possible communication within the network and after each its modification (including or removing a device):

- associating another controller with the network should be performed after associating all devices with the first controller (“PRIMARY”),
- or performing LEARN MODE again on the “SECONDARY” controller already associated with the network.

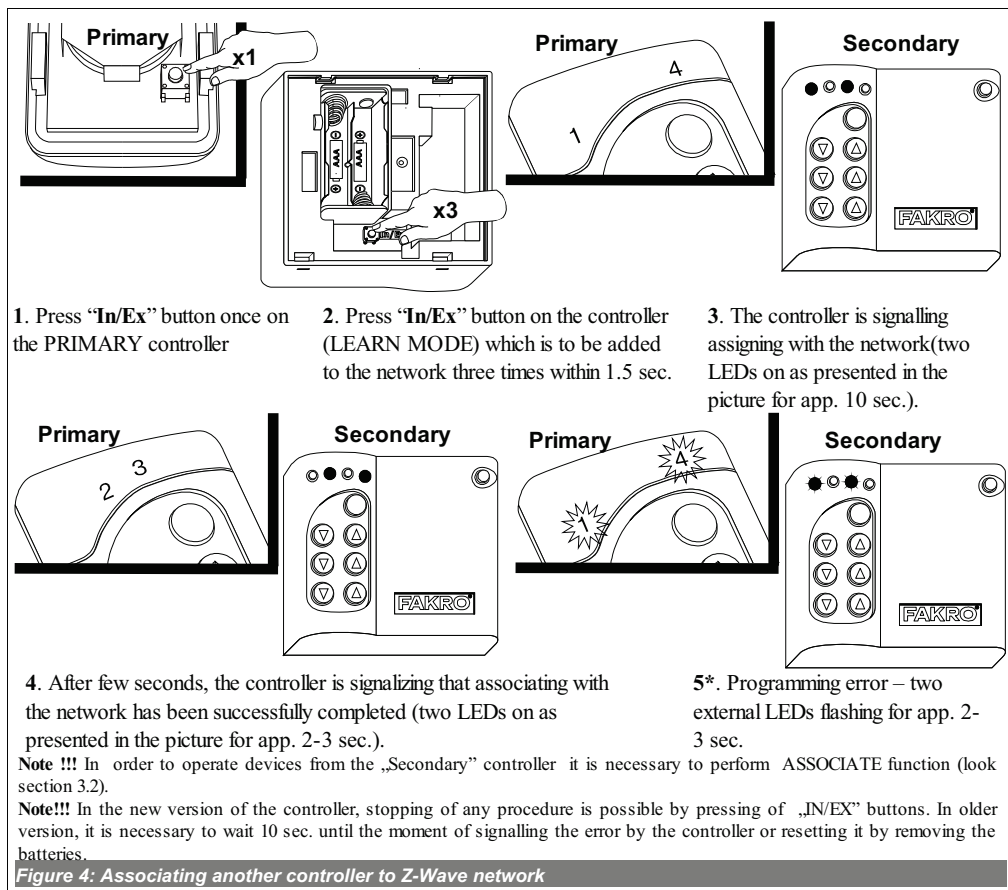

*) Programming error can be caused by:

- failure to enter LEARN MODE on the controller being associated with the network within 10 seconds from primary controller signaling its readiness for adding a new device to the network;
- long distance between the primary controller and controller being added;
- controller already belonging to another network. It is necessary to perform DEFAULT procedure with it and repeat associating with the network.

3.4. Deleting device from a pair of controller buttons (DELETE function)

This function deletes from controller's memory the device associated with a pair of buttons on a selected channel. However, it does not remove the device from the "Z-Wave" network. This function is accessible from PRIMARY and SECONDARY controllers. The procedure of device deleting from a pair of controller buttons is presented in *Figure 5*.

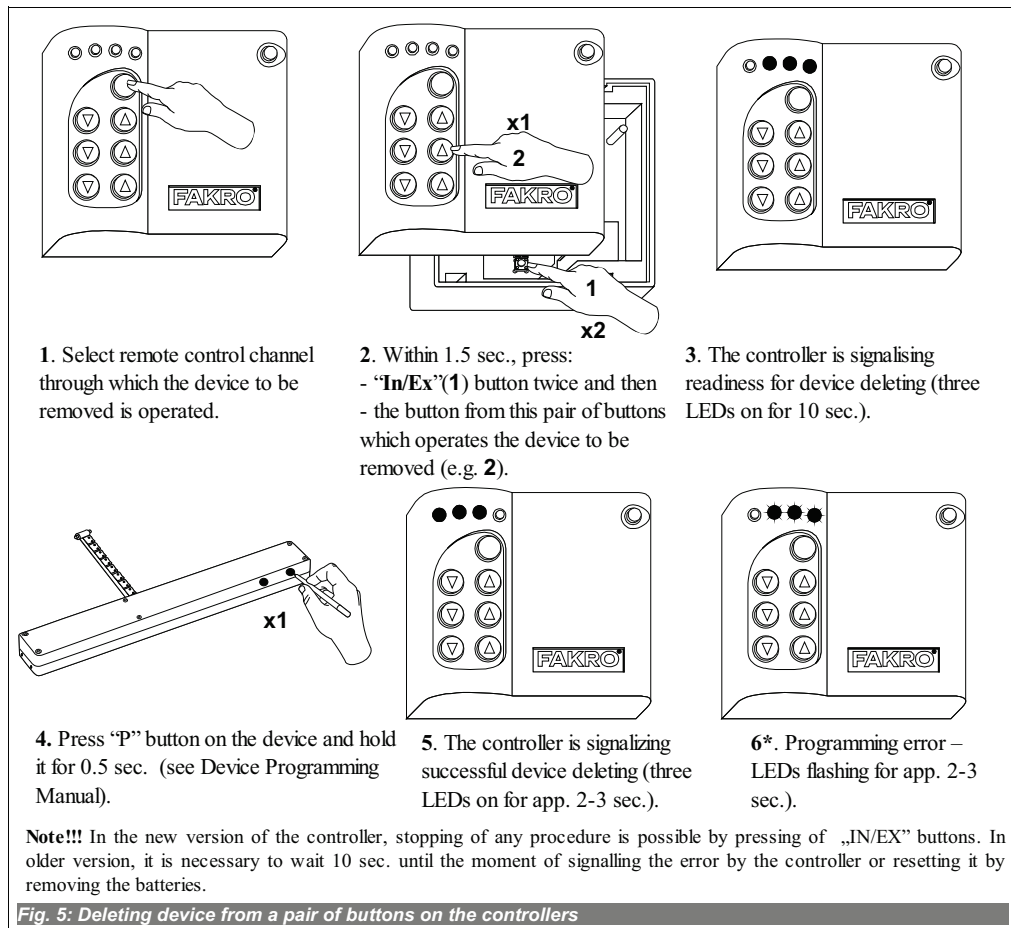

*) Programming error can be caused by:

- failure to press the programming button within 10 seconds from the controller signaling its readiness for deleting the device from selected pair of buttons;
- long distance between the controller and device.

3.5. Excluding device from the network (EXCLUDE function)

Excluding the device from the “Z-Wave” network is possible only with the use of PRIMARY controller (e.g. ZWK15 keyboard). In each network there is always only one primary controller and every other is categorized as SECONDARY. The procedure of device excluding from the network is presented in Figure 6.

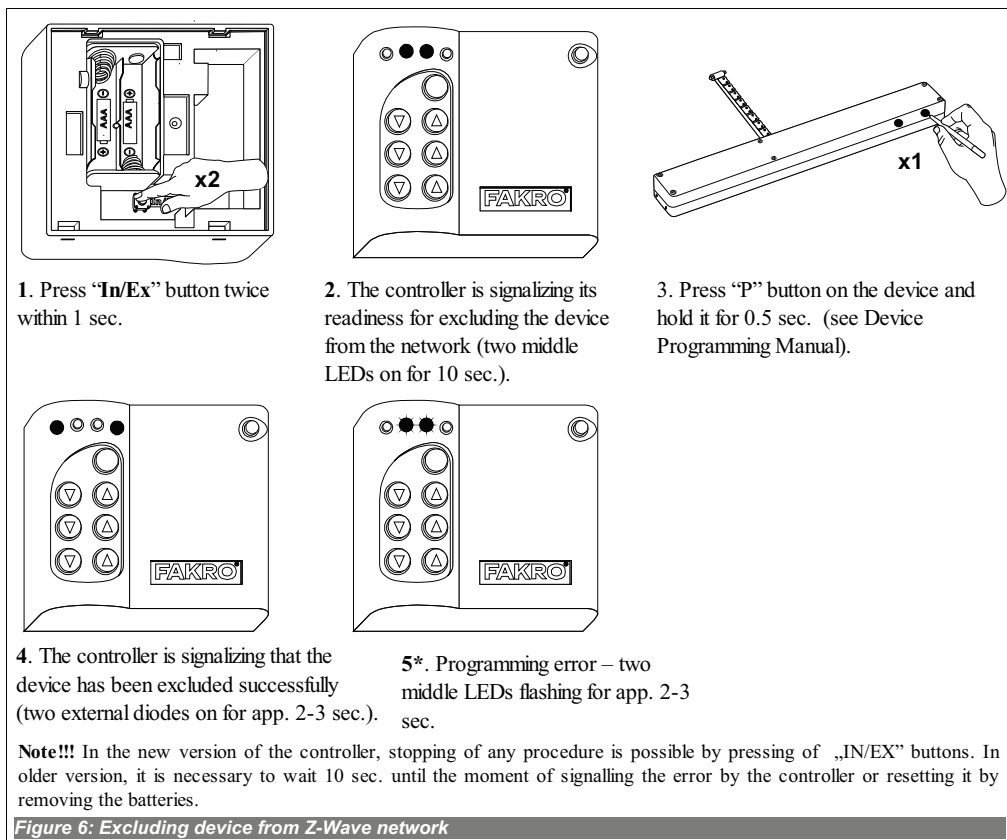

*) Programming error may be caused by:

- failure to press the programming button within 10 seconds from the controller signaling its readiness for excluding the device from the network;
- long distance between the controller and device being excluded.

Note !!! Each device physically deleted from the network (e.g. damaged) shall be deleted from the controller's memory (PRIMARY, SECONDARY), that is, first deleted from a pair of buttons (section 3.4) and then deleted from the network (3.5). Appropriate implementation of procedures aims to provide optimal communication between devices. Disconnecting the device without deleting it from the controller's memory will result in longer time of reaction of devices on commands and faster running out of batteries. In case of necessity of deleting damaged device, which deleting from the controller's memory is not possible, it is recommended to re-configure the whole network (all devices). Configuration of the new network begins with restoring the controller to factory settings (DEFAULT function), and then EXCLUDE function is used and next we go further to the section 3 „Controller programming”.

Note !!! When moving the device within the network, it is recommended to delete it from the controller's memory (first deleting from a pair of buttons, section 3.4) an then deleting it from the network (section 3.5) and re-adding after installation in new workplace.

3.6. Restoring default settings in the controller (DEFAULT function)

Restoring default settings of the controller leads to the following information being deleted from its memory:

- network, to which SECONDARY controller has been added;
- devices in the network for PRIMARY controllers;
- devices associated with pairs of buttons for PRIMARY and SECONDARY controllers.

After performing DEFAULT procedure the SECONDARY controller will be set as PRIMARY.

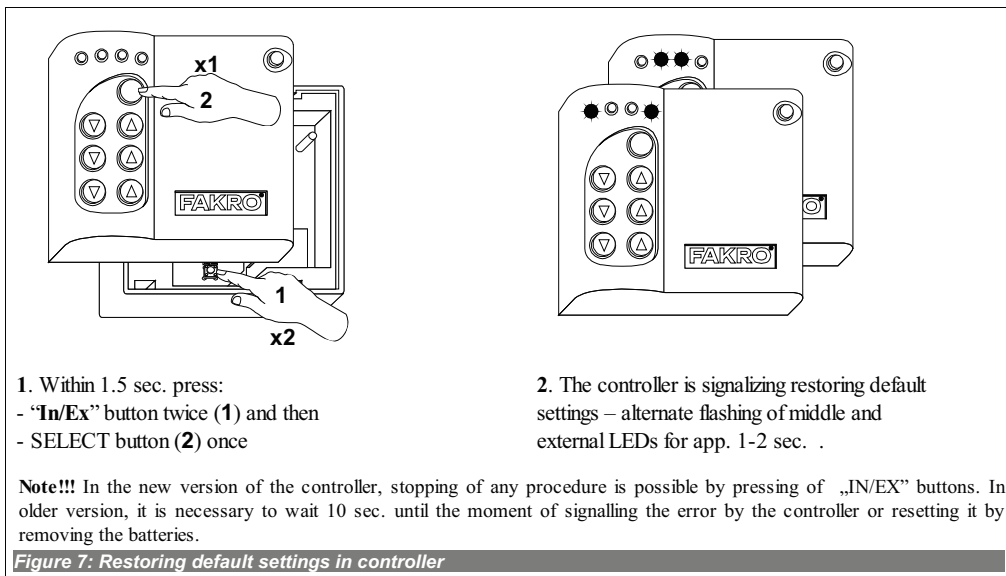

3.7. Removing SECONDARY controller from the network

Removing this controller from the network consists in restoring default settings with the use of DEFAULT function.

3.8. Special function ASSAIN A ROUTE

Note !!! All devices taking part in the below procedure must belong to the same network (must have the same HOME ID).

It is possible to use the controller (ZWK1, ZWK15, ZWP15) to configure the device being outside the direct range of the network, transferring NODE info of the device which is to be controlled to the controlling device memory (controller), to achieve that use ASSAIN A ROUTE Rysunek 8.

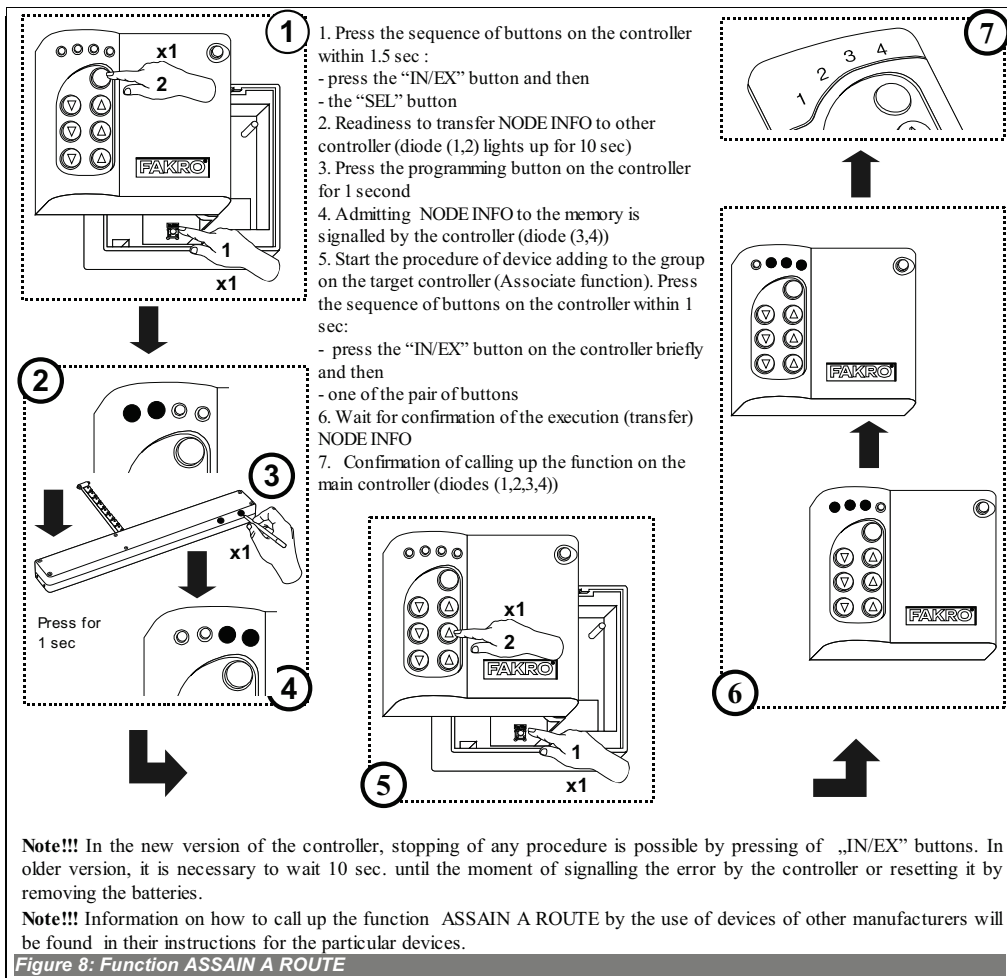

4. Technical parameters

Technical parameters	
Power supply	2x AAA, 3V DC
Working temperature	(+5°C) to (40°C)
Working range	Up to 40 [m]
Working frequency	868,42 MHz

5. Remote control

Note!!! Each command sent from the remote control to the accessory is preceded by a period of accessory awakening. This period usually lasts about 0.3s. In practice, this manifest in delayed reaction lasting for about 0.5 s.

When the accessory remote controlling, 5 commands can be used:

- **Close** – in ZWP, ZWK controllers is activated after short (about 0.5 sec.) pressing of „close” button on the controller and causes the roller shutter launching into the closing direction until the motor reaches the end position, which means that the accessory is completely closed
- **Open** – in ZWP, ZWK controllers is activated after short (about 0.5 sec.) pressing of „open” button on the controller and causes the accessory launching into the opening direction until the motor reaches the end position, which means that the accessory is completely open
- **Start to close** – in ZWP, ZWK controllers is activated after longer (more than 0.5 sec.) holding of „close” button and causes the accessory launching into the closing direction until releasing of „close” button
- **Start to open** – in ZWP, ZWK controllers is activated after longer (more than 0.5 sec) holding of „open” button and causes the accessory launching into the opening direction until releasing of „open” button
- **Stop closing/opening** – in ZWP, ZWK controllers is activated after releasing of „open” button or „close” button with earlier issued command „Start closing”/ „Start opening”. In practice it means, that in order to stop the roller shutter at any position, it is necessary to press particular button and hold until reaching of the desired position, or launching the roller shutter into desired direction by short pressing of appropriate button and then stopping it by pressing (longer than 0.5 sec) and then releasing of the same button.

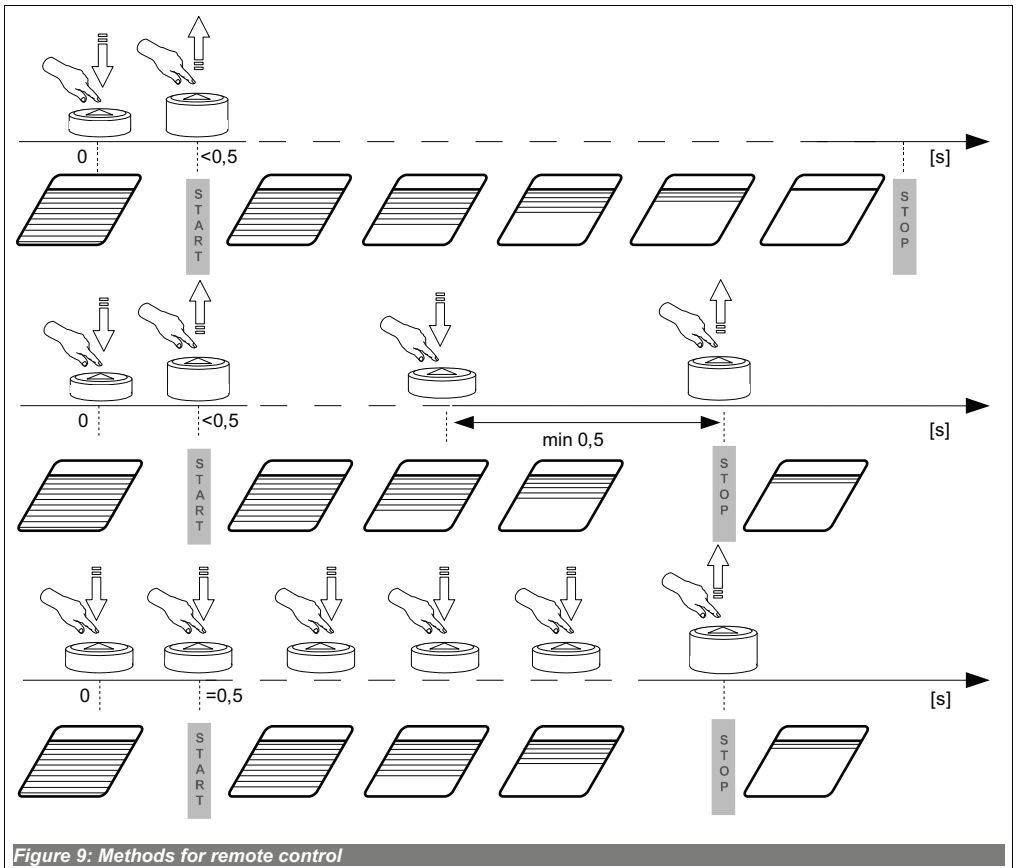
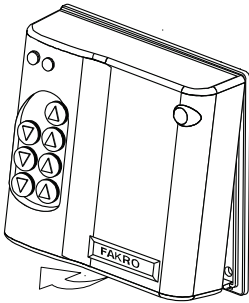

Figure 9: Methods for remote control

6. Battery replacement

With standard controller use (four times a day), the battery should theoretically ensure correct device functioning for the period of 2 years, assuming that the programming procedure has been performed only once. Multiple device programming shortens the battery life.

1. Remove controller from its holder



2. Replace batteries in the socket 2xAAA.

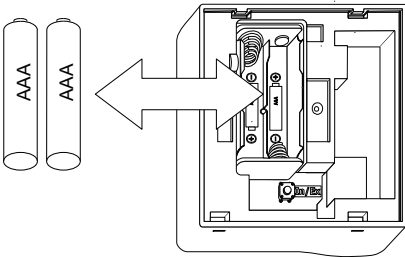

7. WARRANTY

The manufacturer guarantees correct device functioning. It also undertakes to repair or replace the device if its defects result from material or structural faults. The warranty period is 24 months from the purchase date, fulfilling the following conditions:

- Installation has been performed by an authorised individual, as per manufacturer recommendations.
- Seals remain intact and no unauthorised structural changes have been made.
- The device has been used in accordance with its intended use as per user manual.
- Damage is not a result of improperly made electrical system or atmospheric phenomena.
- The manufacturer is not liable for damage which occurred as a result of improper use or mechanical damage.

In case of failure, the device must be submitted for repair with a Warranty Card. Defects revealed within the warranty period will be removed free of charge no longer than 14 days after accepting the product for repair. Warranty and post-warranty repairs are performed by the manufacturer i.e. FAKRO PP. Sp. z o.o..

Quality Certificate:

Device

Model.....

Serial Number.....

Seller.....

Address.....

Date of Purchase.....

.....
Signature (stamp) of installing person

FAKRO PP Sp. z o.o.

ul. Węgierska 144A

33-300 Nowy Sącz

Polska

www.fakro.com

tel. +48 18 444 0 444

fax. +48 18 444 0 333